

Tools Needed for this Installation

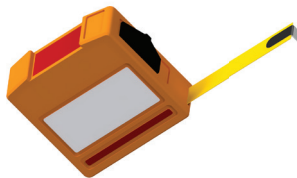

Pencil



Tape Measure



Drill w/
1⁵/₆₄" & 3³/₈" Wood Bits



Socket Wrench
w/ 1¹/₂" Socket

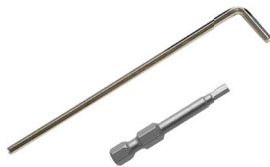

1¹/₄" Hex Head Bit or
1¹/₄" Allen Wrench



Glass Cleaner



Glass Suction
Cup Handles



Torque Wrench
w/ 3³/₈" Hex Head

Things to Know Before You Get Started

- Read over the provided material prior to the start of your installation



YouTube

Visit our YouTube channel to watch helpful installation videos
youtube.com/viewrail

Side Mount Talon Installation Steps

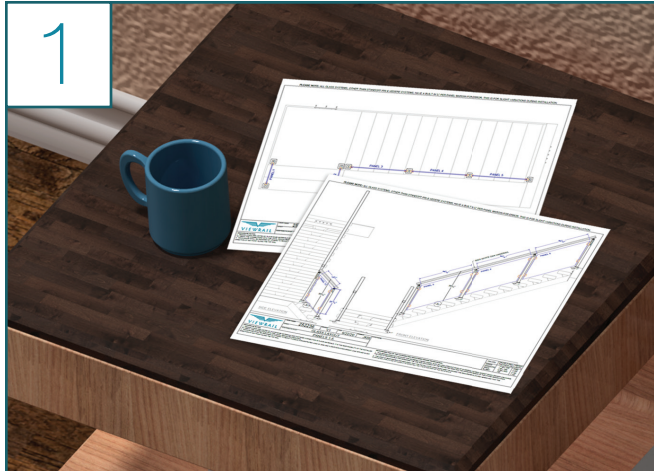

- Refer to your project drawing for proper talon placement
- It will be helpful to measure and mark the talon placement for each talon on the fascia

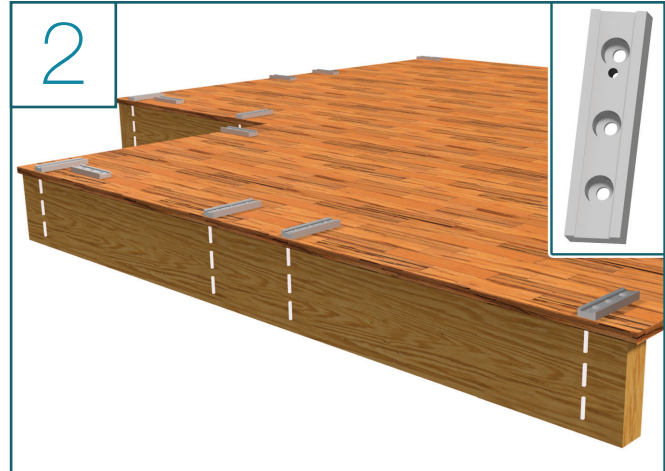

- Lay out your dove tail plates according to your shop drawings
- It may be helpful to mark a vertical line at this point

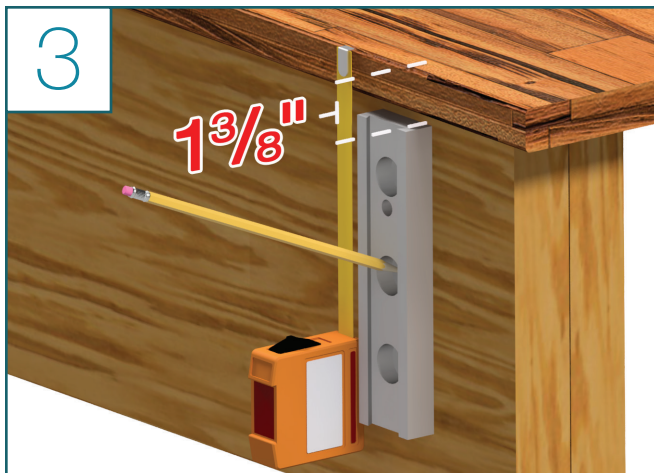

- Place the dovetail plate into position, making sure the plate is square
- The top of the plate should be $1\frac{3}{8}$ " beneath the surface of the deck
- If you are mounting on a skirt board / side of stairs, you will need to move the plates and mount wherever creates a 36" handrail height
- Mark each mounting hole with a pencil

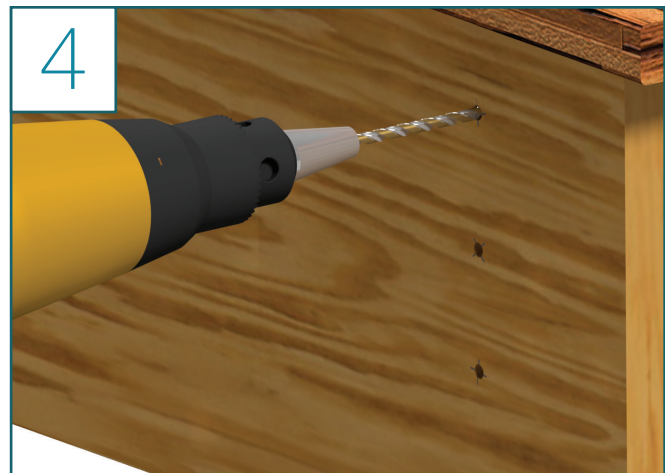

Outside Corners

- Remove the plate and using a $\frac{15}{64}$ " drill bit, predrill on the marks made in step 3

Straights and Inside Corners

- Remove the plate and using a $\frac{3}{8}$ " drill bit, predrill on the marks made in step 3

Side Mount Talon Installation Steps (Continued)

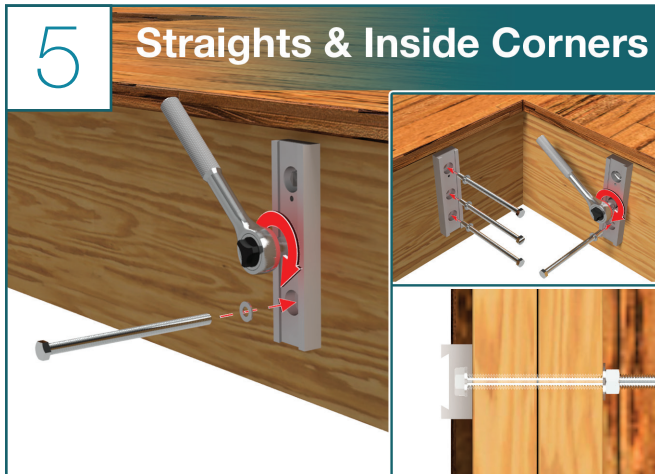

Straights and Inside Corners

- With 3" or more of blocking, through bolts are to be used
- Use a 1/2" socket wrench to drive the 3/8" x 6" tap bolts through a 3/8" washer, the blocking, then another 3/8" washer and finally a 3/8" hex nut
- Shim as needed until plumb
- Lock them down tight

Note: During this step, it is important to double check that each talon's mounting plate is level and square with each of the others in the run.

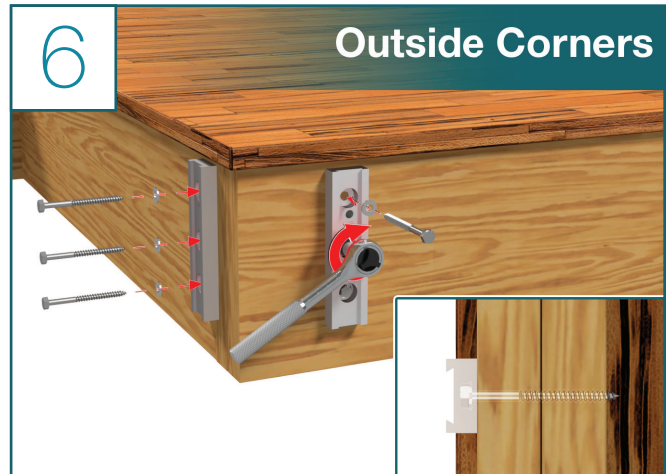

Outside Corners

- With 3" or more of blocking, wood lags are to be used
- Use a 1/2" socket wrench to drive the 3/8" x 4" wood lags through the washer and into the three holes on the dovetail plate
- Shim as needed until plumb
- Lock them down tight

Note: During this step, it is important to double check that each talon's mounting plate is level and square with each of the others in the run.

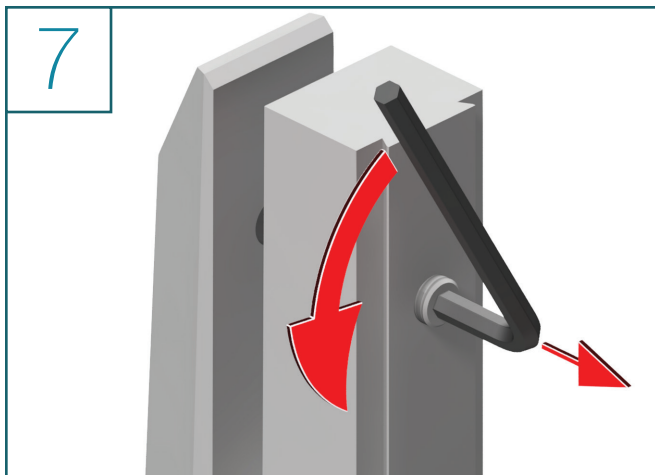

- In order to protect the threads on the back of the talon during the powder coating process, the Pin Lock screw comes pre-threaded in to the talon
- It will be necessary to remove it as it is installed backwards from the factory
- Using a 1/4" Allen wrench, unscrew the Pin Lock Screw
- The Pin Lock Screw will be inserted back into the talon in the following step

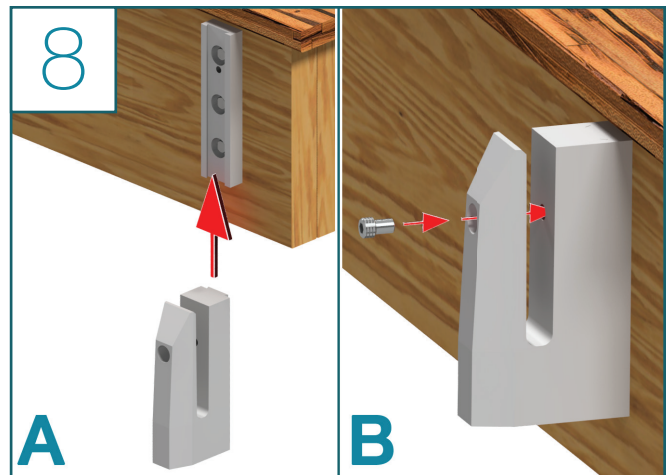

- A: Once the dovetail plate is mounted, take the main body of the talon, and slide it onto the grooves in the dovetail
- B: Using the 1/4" bit or Allen wrench, fasten the Talon Pin Lock Screw through the middle hole of both parts of the talon assembly - The screw should be fastened tightly
- Repeat steps 3-7 for the remaining talons on the run

Side Mount Talon Installation Steps (Continued)

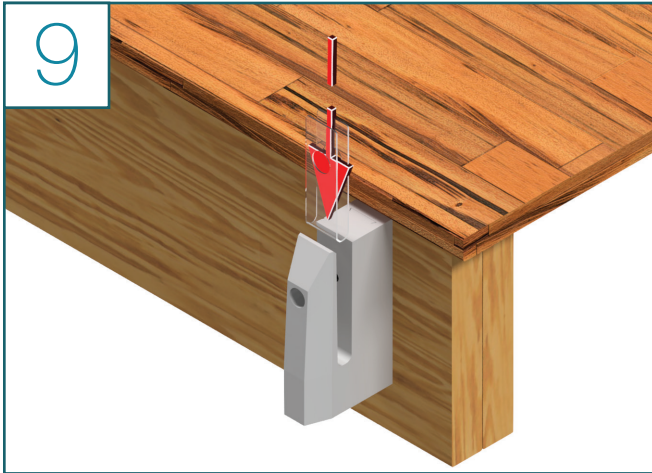

- Slide the Polycarbonate Gasket into place as shown

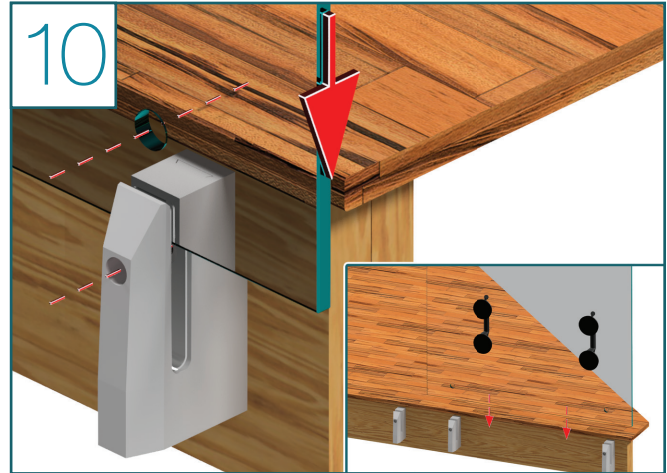

- Using the glass suction cups, grab and move the panel into place
- When setting the glass panel into the talons, make sure the glass goes straight down into the gasket
- If the glass puts a lot of pressure on the gasket you risk pulling that gasket out of place
- Take your time during this step
- Make sure the hole in the glass and the hole in the talon line up

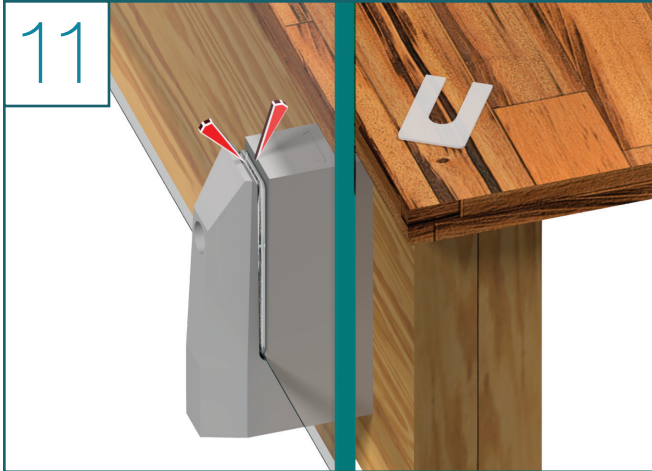

- You may need to slide a Talon Gasket Shim into one or both sides to make a secure fit and to aid in alignment of glass panels

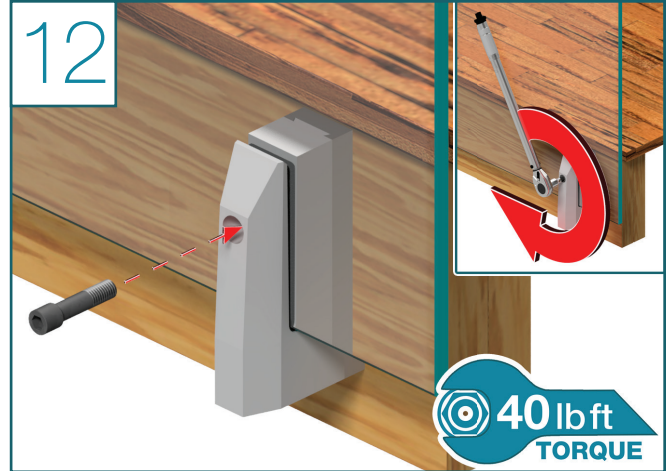

- With the glass panel in place, insert the talon bolt into the assembly
- Using a torque wrench with a $\frac{3}{8}$ " hex head, torque to 40 lb ft
- Make sure the $\frac{3}{8}$ " head is fully seated into the bolt to avoid stripping the bolt - Do not over torque
- Repeat steps 8-11 for all the panels on your run talon and through the glass

Congratulations! You're done with this section.

We'd love to see your work! Snap a few pics with your phone and send them to pictures@viewrail.com. Thanks for choosing Viewrail. Enjoy your new installation!