

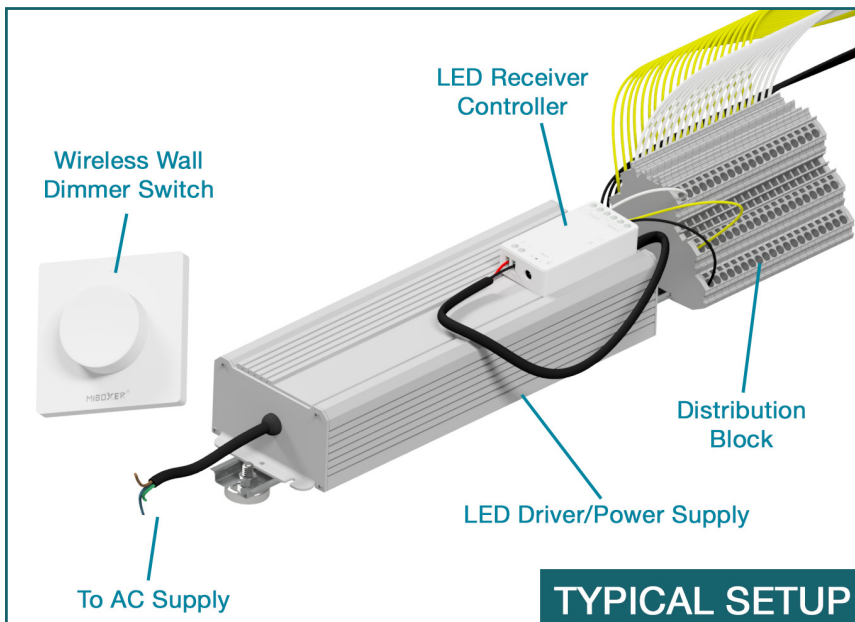

## Safety Precautions

Please take the following precautions:

1. This equipment, like all electrical equipment, should be installed by a qualified person.
2. Do not expose these LEDs, dimmers or power supplies to intense electro-magnetic fields, including lightning.
3. The controllers and power supplies are not waterproof. Keep them dry.
4. Always observe proper polarity.



**i** Please note, do not attempt to adjust the wiring inside the tubing. The only thing needed is to bring power to the power supply box. Viewrail will not be responsible for incorrect re-wiring adjustments.



**i** A note on unfinished treads: It will be necessary to mask off the LED strip installed into the bottom of the tread before any staining can be done.

 **YouTube**  
 Visit our YouTube channel to watch helpful installation videos  
[youtube.com/viewrail](https://youtube.com/viewrail)

# Main Components

<h3>Large LED Power Supply</h3>  <p>Used on stringers with 8 or more treads. Preinstalled into each primary stringer tube. Qty 1 / Stringer</p>	<h3>Small LED Power Supply</h3>  <p>Used on stair systems with 7 or less treads. Preinstalled into each primary stringer tube. Qty 1 / Stringer</p>	<h3>LED Controller</h3>  <p>Quantity of individual terminals may vary. Preinstalled into each primary stringer tube. Qty 1 / Stringer w/ 18 treads or less Qty 2 / Stringer w/ 19 treads or more</p>
--	--	---

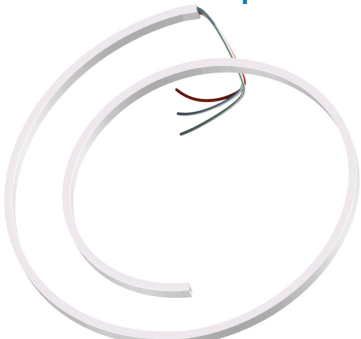
<h3>Distribution Block</h3>  <p>Quantity of individual terminals may vary. Preinstalled into each primary stringer tube. Qty 1 / Stringer</p>	<h3>Wall Mounted Remote</h3>  <p>Qty 2 / Flight System</p>	<h3>Spring Connectors</h3>  <p>You may receive ones w/ 3 or 4 connector clips. Qty 1 / Tread</p>
---	--	--

<h3>LED Strip</h3>  <p>Preinstalled into each tread Qty 1 / Tread</p>	<h3>Button Cell Battery</h3>  <p>Used to power the Wall Mounted Remote. Qty 2 / Flight System</p>
--	--

*Images not to scale*

## LED Tread Installation Steps

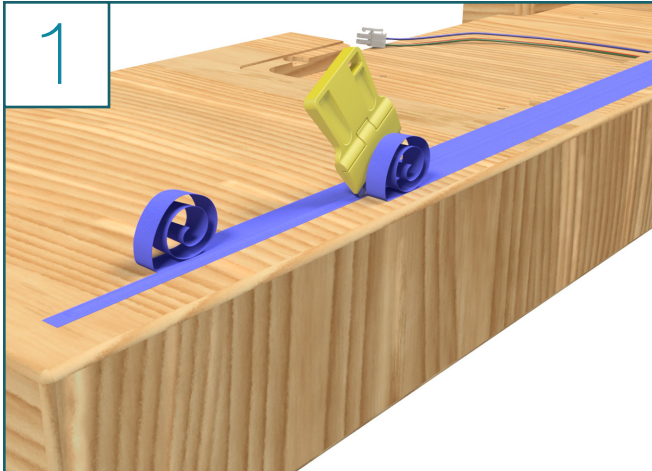

### THIS STEP IS ONLY FOR UNFINISHED TREADS

- Using painter's tape, mask off the LED channel prior to finishing your treads
- **If you ordered finished treads, skip to step 2**

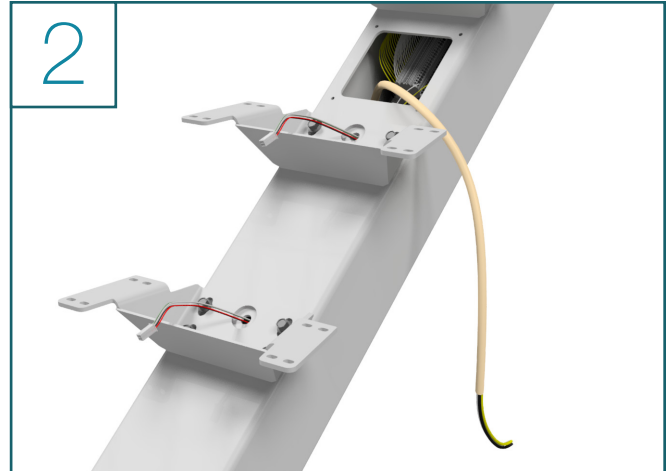

- The stringer should be mounted by this step, the power disconnected & a 120V AC line run through the stringer
- Pull enough slack to let the line hanging out of the LED access panel

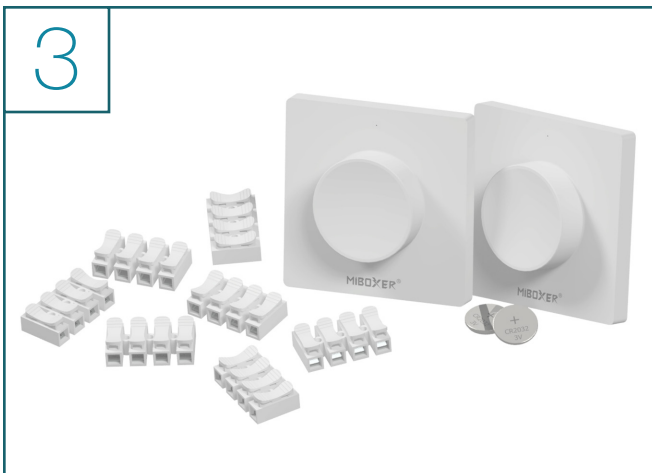

- Locate all of the Wire Spring Clips, Wall Mounted Remotes & Button Cell Batteries
- These will be used in later steps



- Before commencing any installation or maintenance work, disconnect power at the breaker box and ensure that it cannot be re-connected inadvertently



**A licensed Electrician is required for the following step. Incorrectly connecting the system to power may result in; damage to the components, electric shock, fire or death.**

LED Tread Installation Steps (Continued)

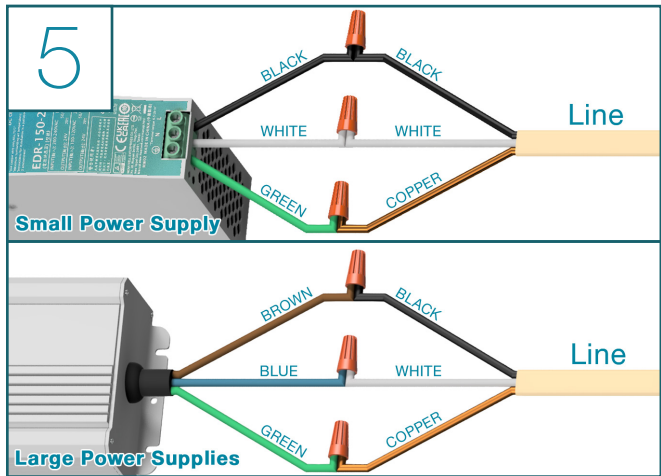

	Power Driver	Line
Small Power Supply	Live/ACL	Black to Black
	Neutral/CAN	White to White
	Ground/FG/PE	Green to Copper
Large Power Supply	Live/ACL	Brown to Black
	Neutral/CAN	Blue to White
	Ground/FG/PE	Green to Copper

*It may be necessary to remove the power supply from the stringer to make connections.*

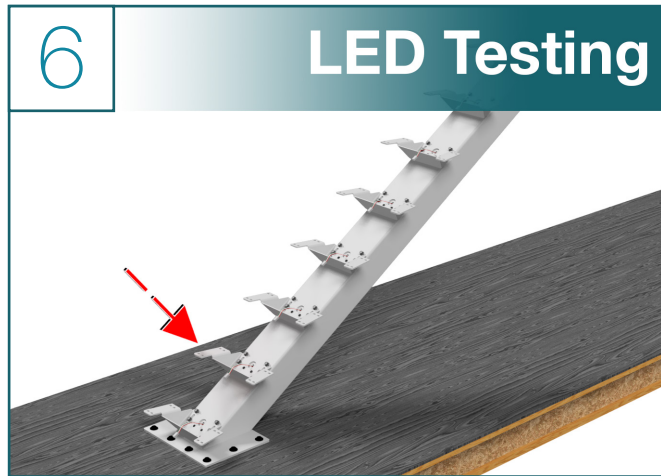

- Pick a single tread location where you will test the functionality of the LED system
- Take a look at your stringer harness and tread harness and identify which configuration you have (6a-6c) and follow the directions to connect your stringer and tread harness

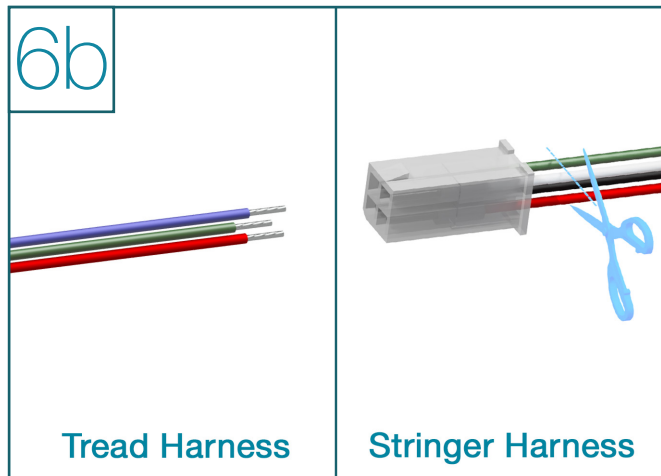
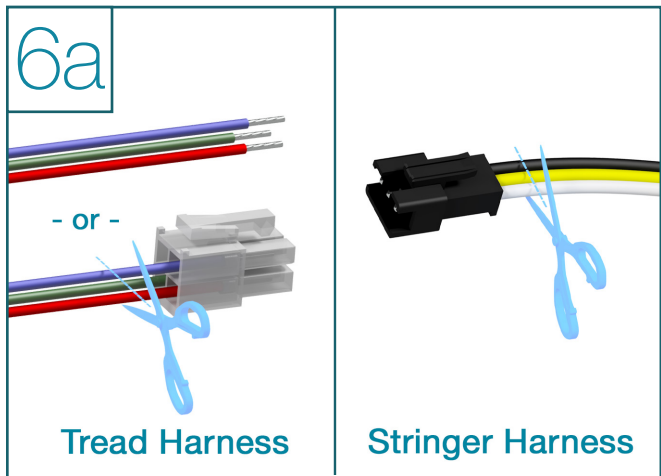

- Depending on if you have one or two plugs, cut one or both of them off
- Match the following Wires using a wire spring clip:  
**Red >> White / Blue >> Yellow / Green >> Black**

*Note:*  
*For more clarity on how to use a spring clip, go to steps 7a & 7b. If you have both harnesses connected successfully, tuck the excess wire into the pocket of the metal tread bracket, secure the tread, and skip to step 8.*

- Cut off the plug from the tread harness
- Match the following wires using a wire spring clip:  
**Red >> Red / Blue >> White / Green >> Black**

*Note:*  
*For more clarity on how to use a spring clip, go to steps 7a & 7b. If you have both harnesses connected successfully, tuck the excess wire into the pocket of the metal tread bracket, secure the tread, and skip to step 8.*  
*If you do not have RGB strips, the GREEN wire out of the stringer harness is NOT needed. Simply tape it off and tuck it back into the stringer.*



## LED Tread Installation Steps (Continued)

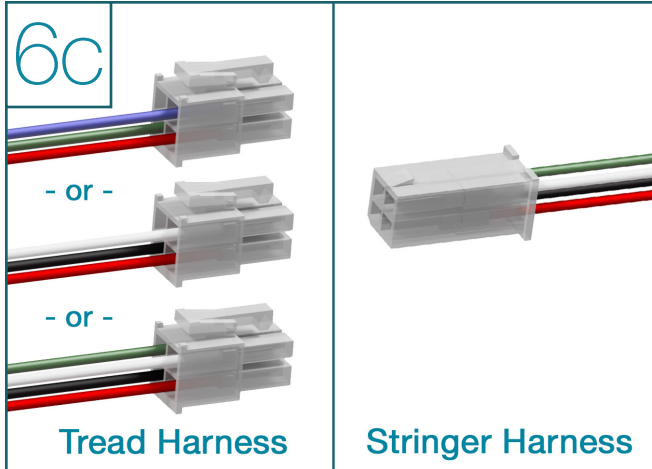

- Plug the tread Harness into the stringer connector
- Now the tread harness and stringer harnesses have been connected, tuck the excess wire into the pocket of the metal tread bracket, secure the tread
- **Skip to step 8**

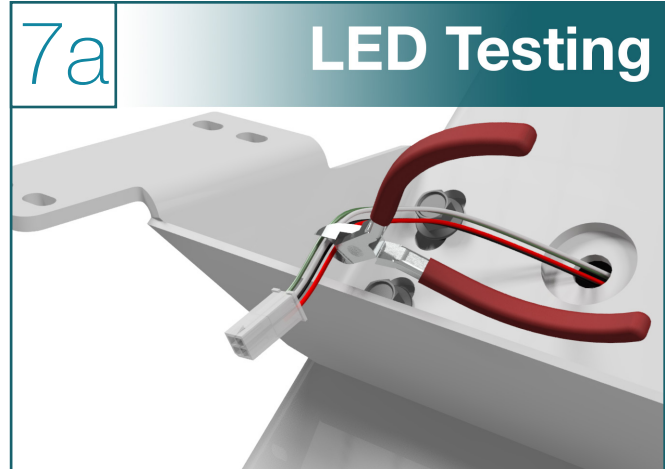

### **i** Harness Configurations: 6a & 6b ONLY

- Check again, to ensure the power is off to the stringer
- Using a wire cutters, cut off the plug from the harness directly below the plug head

*Note:*

*If you do not have RGB strips, the GREEN wire out of the stringer harness is NOT needed. Simply tape it off and tuck it back into the stringer.*

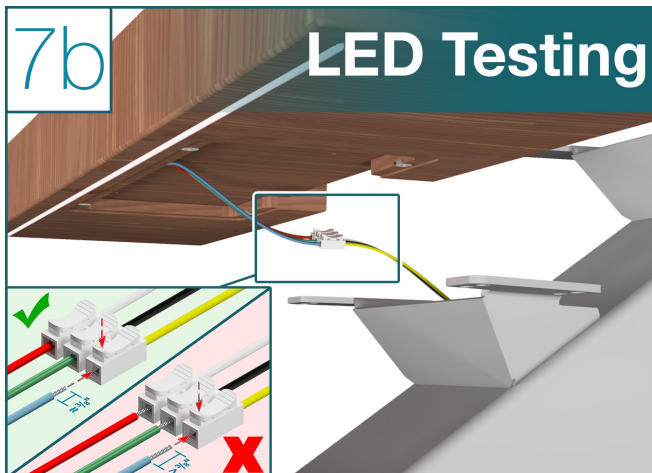

### **i** Harness Configurations: 6a & 6b ONLY

- Using a wire strippers, strip  $\frac{3}{8}$ " off of the wire casing from each wire
- Following your harness wire configuration (steps 6a-6c), ensure that there is no bare wire showing outside the spring clips, trim the bare wire if needed and reinsert it
- Once the wires are secured into the quick connect, tuck all of the slack wiring into the pocket of the metal tread bracket and secure the tread

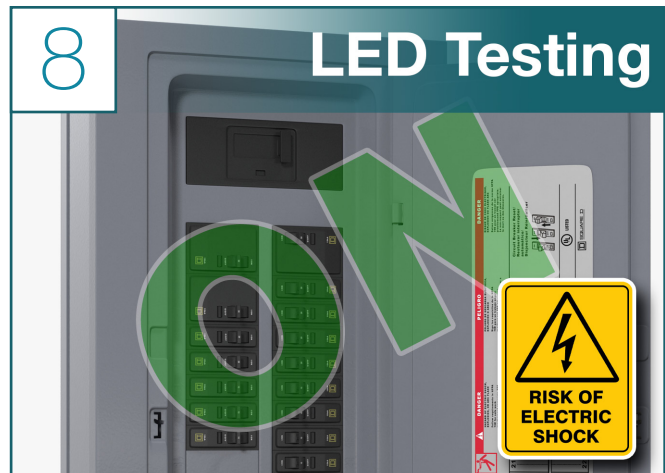

- At this point, check to make sure your new connections are isolated from any source of grounding, and turn the power back on

LED Tread Installation Steps (Continued)

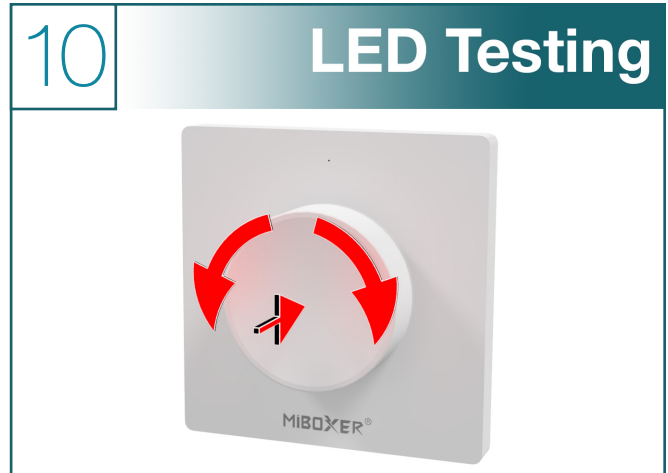
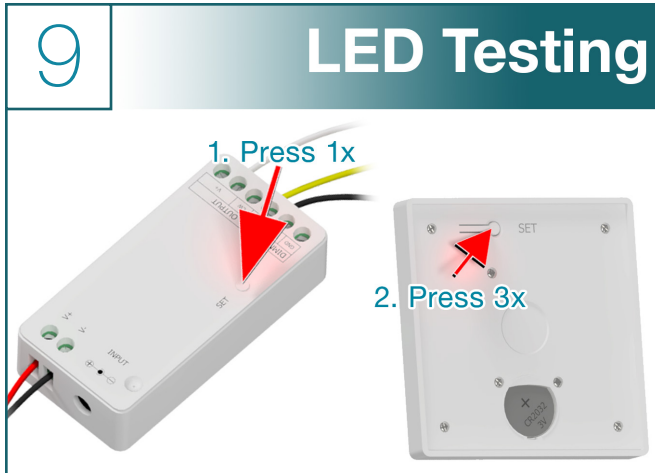

- It will be necessary to program the Wall Mounted Remotes in order to test the system
- Install the provided 2032 button cell battery into the back of the remote
- Press the SET button on the LED Controller (found inside the access panel in the stringer tube) 1 time
- Within 30 seconds, press SET button on one of the Wall Mounted Remotes, 3 times
- Repeat the process for adding additional remotes

- Operate the remotes to test functionality of the system
- Press the dial to turn the lights on and off
- Turn the dial clockwise to increase brightness and counterclockwise to make it dimmer
- With the lights on, press and hold the dial for 3 seconds to switch to color temperature adjustment mode
- In this mode, turn the dial to adjust the temperature of the light

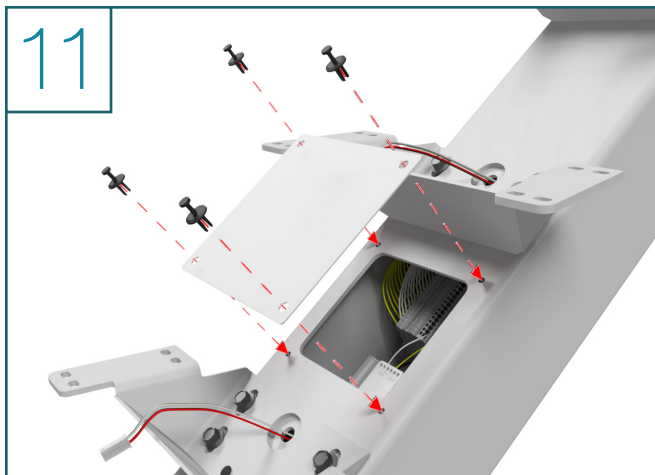

- Once the LED's have been tested, and all remotes have been paired, close up the access panel using the supplied plastic retention clips



- Before commencing any installation or maintenance work, disconnect power at the breaker box and ensure that it cannot be re-connected inadvertently

## LED Tread Installation Steps (Continued)

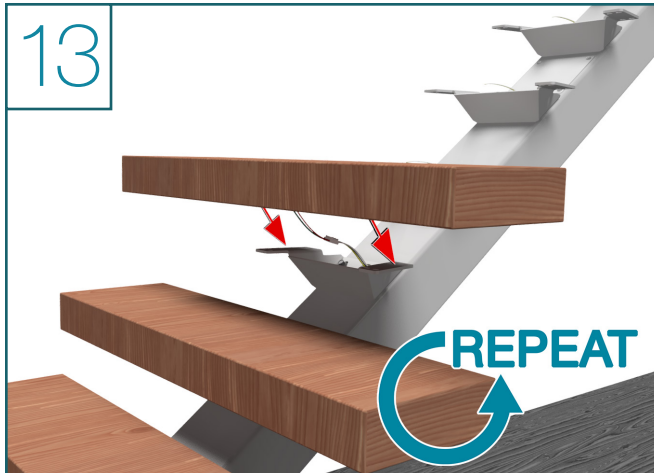

- Repeat Steps 6-7 for the remaining treads

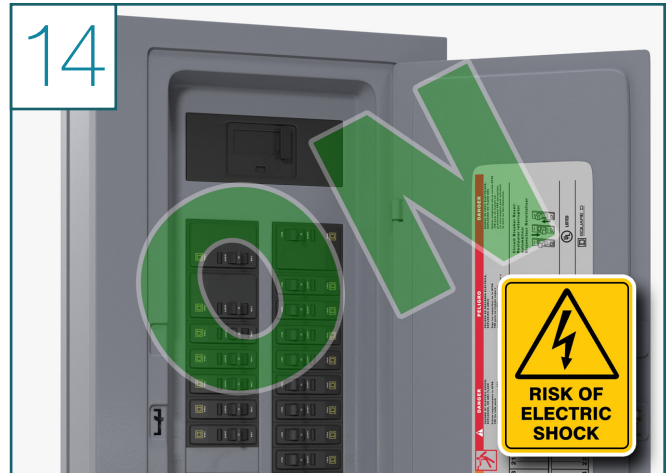

- It is now safe to turn the power back on

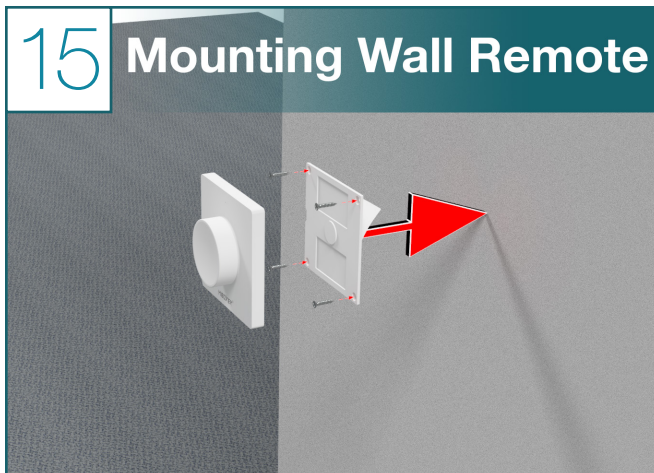

- Peel off the backing from the wall plate and press firmly to the wall
- Optional: Use 4 small mounting screws (not provided) to secure the 4 corners of the backplate to the wall
- You can use a level to ensure that it goes on plumb
- Once the back plate is adhered to the wall, clip on the front plate

## Mobile Smart App Set Up for Viewrail LED Lighting

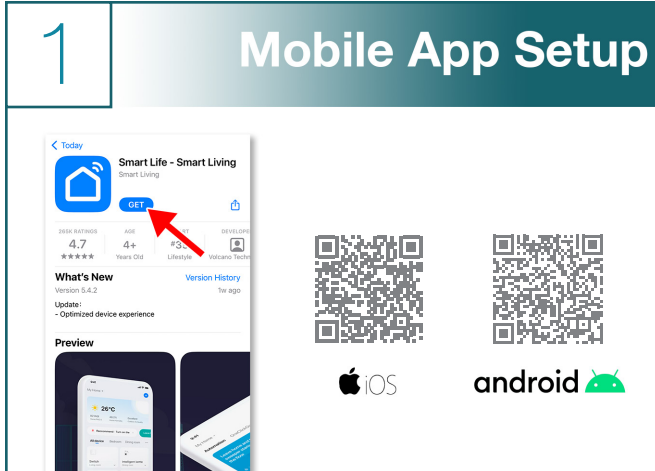

- Search for the **Smart Life** app in the Apple App Store or in the Google Play Store, or use the QR Codes above for direct links

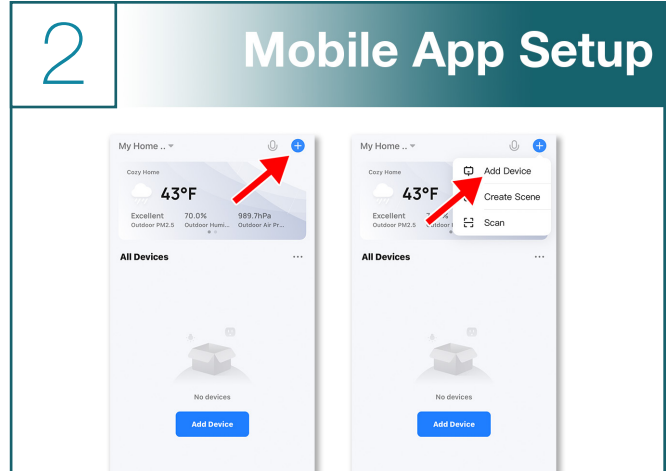

- Open the App and press the “+” button
- Select “Add Device”

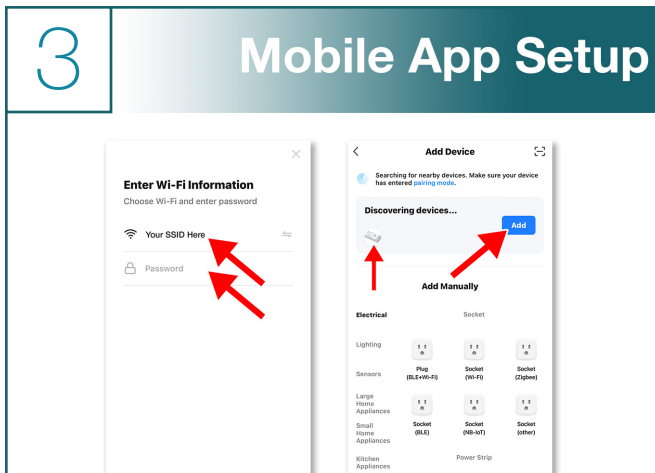

- Search and select your Wi-Fi Network when it displays
- Enter your networks password and press “Next”
- The app will start searching for compatible devices
- Once the image of the LED Controller shows up, click on “Add”
- Once paired, you will be able to control the lighting via the app

**Congratulations!**  
You're done with this section.

We'd love to see your work! Snap a few pics with your phone and send them to [pictures@viewrail.com](mailto:pictures@viewrail.com). Thanks for choosing Viewrail. Enjoy your new installation!



# Warning:

## **TO REDUCE THE RISK OF FIRE, ELECTRIC SHOCK OR INJURY TO PERSONS:**

1. Turn off/unplug before mounting or interconnecting fixtures.
2. Do not look directly into LEDs when lit.
3. Do not operate fixture(s) with missing or damaged parts.
4. Do not install fixture(s) in any unventilated compartment.
5. Use only UL/RU/ETL Listed Class 2 power supplies, shown below.
6. Use only NSL joiner or extension cords to join fixtures to Class 2 LED Driver and to interconnect fixtures.
7. Properly dispose of all small parts and packing material. Small parts and packing material may be hazardous to children.
8. Do not use Mini USB power cords or extension cords for any other product.
9. Install in accordance with manufacturer's instructions, current local codes, and/or the current National Electric Code.
10. Your system is specifically design with the appropriate power supply for the amount of LEDs installed. Adding additional LEDs may result in premature failure of the LED system.
11. Do not install products outside or near any water source.
12. Before installing, ensure that product voltage corresponds to local power voltage.
13. Do not use this product for any other purpose than as described.
14. Do not use this product with unauthorized accessories or parts from other manufacturers.
15. LED lighting is not intended to replace any emergency egress lighting.
16. Do not try to adjust, fix, rewire, LED stair fixtures.

In the unlikely event fixture does not illuminate, check wiring first. If this does not work, send LED back for warranty replacement, if applicable.

These products may represent a possible shock or fire hazard if improperly installed or attached in any way. Products should be installed in accordance with the owner's manual, current local codes, and/or the current

National Electrical Code (NEC). Products must be installed and wired by a licensed electrician.

**FAILURE TO ADHERE TO THESE WARNINGS AND INSTRUCTIONS CAN RESULT IN FIRE,  
SERIOUS INJURY, ELECTRICAL SHOCK, AND/OR DEATH.**

# Troubleshooting:

## Tools Required:

- Auto Detecting Multi-Meter
- Voltage Detecting Pen
- Small Flat Head Screwdriver

### Issue: All LEDs Not Turning On

#### A. Check and replace battery in Remote

#### B. Check to make sure 120v is on and connected to the power supply with voltage detecting pen

- Breaker could be flipped or light switch could be turned off
- Check wire connections
- If power is good move to **Step C**
- If no 120V power is present call a certified electrician

#### C. Check that the low voltage power supply has 24VDC power supplying the driver with multi-meter

- Check wire connections
- 24VDC can vary between 24-25.5VDC
- If 24VDC is good move to Step D
- If no 24VDC power is present replace the low voltage power supply
- Check that the driver has 24VDC to the LED strips when turned on
- Make sure the driver is at full brightness and tuned to 1 specific color temperature (Dimming and tuning can lower the voltage below 24VDC)
- Check wire connections
- Reprogram the remote to the driver
- If driver is working correctly move to **Step D**
- If driver is not putting out 24VDC replace driver

#### D. Check LEDs

- Make sure all LEDs are wired correctly.
- There are 3 versions of LEDs so make sure the wiring is correct for the specific version of LEDs you are using
- To verify the version, remove an LED tread bracket - the wiring attached to the LED (not the wire in the stringer) should be black (*24VDC+*), yellow (*24VDC- warm white*) and white (*24VDC- cool white*) **or** red (*24VDC+*), green (*24VDC- warm white*) and blue (*24VDC- cool white*)
- If LED is routing directly in the tread follow the red, green, blue style
- Some treads may only have 1 color temperature and only 2 wires would be connected rather than the 3

### Issue: Remote not working

#### A. Check and replace battery in Remote

#### B. Try remote closer to the driver

#### C. Reprogram remote

#### D. Replace remote

### Issue: Not All LEDs are working

#### A. Verify the wiring connections of the LEDs

#### B. Test non-working strip with a known working connection

- If the LED strip tests good when connected to a known working harness, then the original wiring is bad and will need to be replaced
- If the LED strip does not work on a known working harness, then the LED strip is bad and will need to be replaced